



Way of Life!

THE
ULTIMATE™
4-STROKE OUTBOARD



2019

SUZUKI GENUINE PARTS AND ACCESSORIES





QUALITY. RELIABILITY. INNOVATION.

PEACE OF MIND GUARANTEED

Our outboards are respected by boaters worldwide for their quality, dependability, innovative design and superb engineering. You'll find the same skill, excellence and attention to detail in our Suzuki Genuine Parts and Accessories.

From our classic line of instruments and gauges to custom-engineered propellers and rigging kit, you can depend on Suzuki Genuine Parts and Accessories for outstanding performance, durability and reliability. Whatever type and model of Suzuki outboard you own, you'll find accessories and options designed specifically to match it, and help you get the most from it.

To discover the full range, and find out more about ordering, fitting and using the accessories in this brochure, please talk to your local Authorised Suzuki Dealer.

TABLE OF CONTENTS

1	OPERATION SYSTEMS	06
	Mechanical remote controls	08
	Suzuki Precision Control	12
	Gauges	16
	Multi-Function Display	20
	Diagnostic mobile app	26
	Keyless Start System	28
2	SUZUKI PROPELLERS	30
	Watergrip	32
	Propeller range	34
3	UTILITY EQUIPMENT	36
	The Suzuki range	38
4	MAINTAINING YOUR SUZUKI	40
	For peace of mind	42
	ECSTAR	44
	Genuine oil	46
5	RECOMMENDED STEERING KITS	48
	Steering systems	50
6	APPLICATION CHART	54
7	MERCHANDISE	58

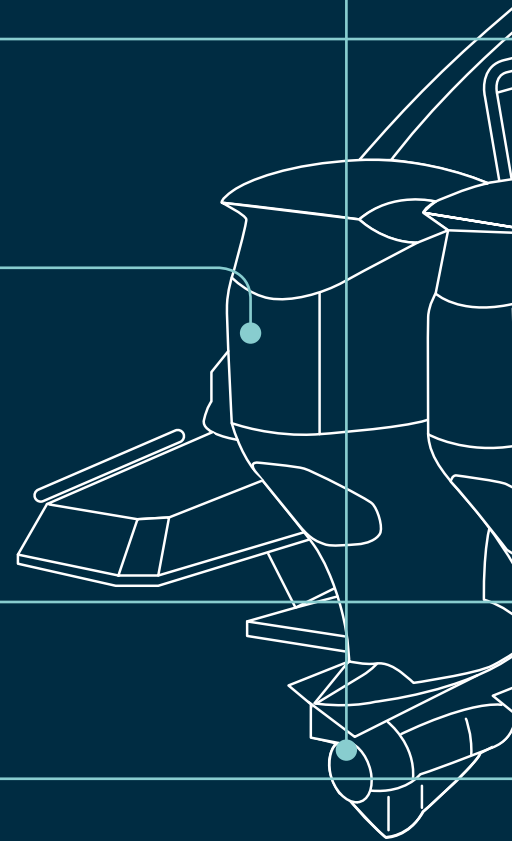

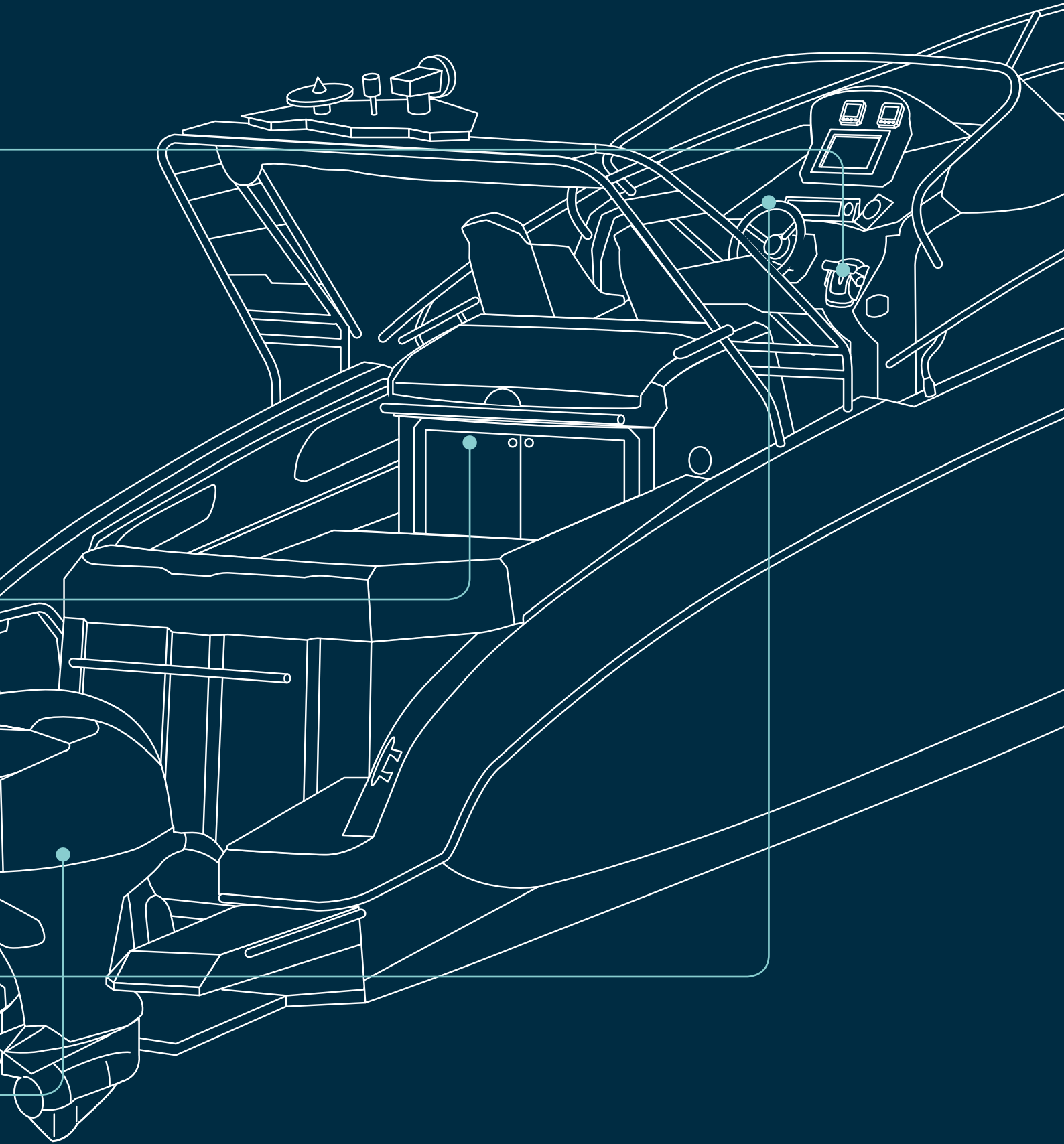

1 OPERATION SYSTEMS

CONTROL. ELEGANCE. WORLD-FIRST.







OPERATION SYSTEMS

MECHANICAL REMOTE CONTROLS

Binnacle and flush mounts

Suzuki mechanical remote controls improve user-friendliness and give the driver even greater control and movement of the throttle through the optimum ergonomic design as well as a quality look to any boat console.

NEW DESIGN

Our ever-popular Mechanical Remote Control Box has been completely reinvented by our finest engineers and most talented designers. With its ergonomic chamfer design, this new model not only makes your boating easier, smoother and more comfortable, it also looks fantastic on your console.



FEATURES

- Unique chamfer grip is elegant and eye-catching.
- Design matches our Multi-Function Gauge to give your console a harmonious, integrated look.
- Lever has been fully ergonomically tested to optimise it for most hand sizes.
- Shifting is smooth and positive.

BINNACLE-MOUNT REMOTE CONTROL BOX (FOR SINGLE-ENGINE)



67200-88L00-000
DF8A - DF250

With its elegant design, smooth movement and the ergonomic chamfer grip, the Single Remote Control Box adds new levels of precision, comfort and control.

BINNACLE-MOUNT REMOTE CONTROL BOX (FOR DUAL-ENGINE)



67200-88L10-000
DF8A - DF250

The Dual Remote Control Box is a masterpiece of ergonomic design, with its chamfer grips, and power trim and tilt switches in easy reach to make boating easier and more relaxing.



**FLUSH-MOUNT REMOTE CONTROL BOX
(FOR SINGLE-ENGINE)**



67200-93J33-000
DF8A - DF250

**SIDE-MOUNT REMOTE CONTROL BOX
(FOR SINGLE-ENGINE)**



67200-93J51-000
DF9.9B - DF250

For reliable, relaxing boating, you need controls you can count on, whatever the conditions. So, through clever engineering and design, we've made our Flush-Mount and Side-Mount Remote Control Boxes as simple and robust as possible. That way, you can be confident you've got all the functions and control you need, and that they'll keep working flawlessly for years to come.



OPERATION SYSTEMS

MECHANICAL REMOTE CONTROLS Switch panels

To make boating even easier and reliable for you, we've developed a range of robust, waterproof, easy to use switch panels for your remote control boxes. Please ask your local Authorised Suzuki Dealer for more details.

EMERGENCY SWITCH PANEL



37803-93J05-000
DF9.9B-250

PTT SWITCH PANEL



37805-93J00-000
DF40A-250

IGNITION SWITCH PANEL SINGLE IGNITION



37100-96J00-000
DF9.9B-250

LIGHTING SWITCH PANEL



37210-93J00-000
DF9.9B-250

IGNITION SWITCH PANEL (SINGLE IGNITION WITH EMERGENCY-STOP SWITCH)



37100-96J25-000
DF9.9B-250

IGNITION SWITCH PANEL (DUAL IGNITION WITH EMERGENCY-STOP SWITCH)



37100-96J15-000
DF9.9B-250



TROLL MODE SWITCH PANEL

Available as an option on all remote control models from DF40A upwards, this easy-to-use system lets you adjust your engine speed in 50rpm increments for precision control at low revs. It has its own tachometer and control switch, and works alongside our Multi-Function and analogue gauges.

*Also available for
Suzuki Precision Control

DF40A-200A / DF150AP-300AP/
DF325A / DF350A

OPERATION SYSTEMS

SUZUKI PRECISION CONTROL Our drive-by-wire system

Suzuki Precision Control uses our most advanced technology to give you precise, effortless control for truly relaxing and enjoyable boating.

Conventional control systems use mechanical cables to activate the throttle. With Suzuki Precision Control, a computer sends signals to the engine electronically by wire, eliminating friction and making shifting easier and smoother. Plus, the system processes and transmits commands in real time to actuators in the engine, delivering precise, instant throttle responses for greater control and accuracy. It also has built-in features to help protect the engine and drive from damage, so you can enjoy your boating life to the full.



LEAN BURN TECHNOLOGY

Fuel efficiency matters whether you're boating for pleasure or profit. Our Lean Burn Fuel Control Technology combined with Suzuki Precision Control, delivers the optimum fuel/air mixture to the engine. The system is designed to save fuel both at low speeds and up into the cruising range.

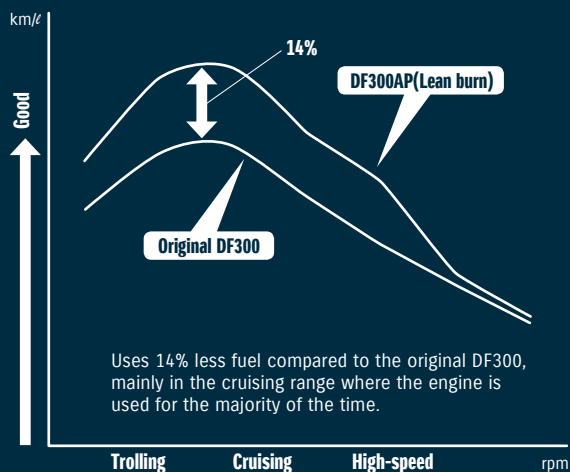

* Results vary depending upon operating conditions.

FEATURES

- Drive-by-wire technology delivers smoother, more positive control.
- Power is transmitted smoothly, instantly and precisely when required.
- Works seamlessly with Suzuki's Lean Burn Control system to deliver remarkable fuel economy over a wide operating range.

BINNACLE-MOUNT REMOTE CONTROL BOX (FOR SINGLE ENGINE)



67200-98J04-000
DF150AP-DF350A

BINNACLE-MOUNT REMOTE CONTROL BOX (FOR DUAL ENGINE)



67200-98J14-000
DF150AP-DF350A

FLUSH-MOUNT REMOTE CONTROL BOX (FOR SINGLE ENGINE)



67200-98J23-000
DF150AP-DF350A

Our sophisticated drive-by-wire system eliminates the friction and resistance of mechanical control cables. This gives smooth, precise control with crisp, immediate shifting, particularly at low revs and when manoeuvring. The system can be configured with single, twin, triple or even quadruple installations, and for dual stations.

OPERATION SYSTEMS

SUZUKI PRECISION CONTROL

Switch panels

In our constant pursuit of easier handling and improved safety functions, we've created a range of panels and options for your Suzuki Precision Controls.



MAIN SWITCH PANEL (SINGLE IGNITION WITH EMERGENCY-STOP SWITCH)



37100-98J05-000
DF150AP/175AP/200AP/250AP/300AP/
325A/350A

CONTROL PANEL (FOR SINGLE-ENGINE)



37100-98J11-000
DF150AP/175AP/200AP/250AP/
300AP/325A/350A

CONTROL PANEL (FOR DUAL-ENGINE FOR QUADRUPLE)



37100-98J21-000
DF150AP/175AP/200AP/250AP/300AP/
325A/350A

CONTROL PANEL (FOR TRIPLE-ENGINE)



37100-98J31-000
DF150AP/175AP/200AP/250AP/300AP/
325A/350A

These panels are designed to bring all the controls for your outboards together whether you have a single rig or multiple outboards. Ergonomic buttons make it easy to start and stop your engine at the push of a button and control trim and tilt with ease. Multiple outboards can simply be synchronised for control from one set of buttons.



SUZUKI SELECTIVE ROTATION

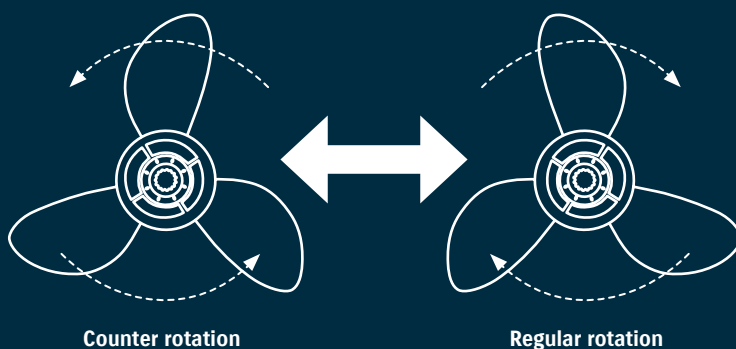

36612-98J20-000
CONVERTS DF150AP/175AP/200AP/250AP/300AP
TO COUNTER ROTATION SPECIFICATION

SELECTIVE ROTATION CONNECTOR

If you have a large boat with two engines, you generally need to pair a standard rotation outboard with a counter rotation model. Our Suzuki Selective Rotation system allows you to select the rotation direction on any Suzuki outboard. So instead of buying a dedicated counter rotation model, all you need is a standard outboard, a suitable propeller, and our simple Selective Rotation Connector.

OPERATION SYSTEMS

GAUGES

Analogue gauges

At Suzuki, we understand that everyone enjoys boating in their own unique way. For some of us, that means having a console equipped with all the latest digital gadgets and displays. But if you still prefer analogue gauges, we have a complete range of instruments designed to give your console that classic old-school look and feel.



NEW TECHNOLOGY, OLD-SCHOOL LOOK

All our analogue gauges are simple and elegant, with crisp, clear dials that are intuitive and easy to read for confidence and peace of mind on the water.

TACHOMETER

Our full-scale tachometers indicate engine revs up to 7000 rpm, with options including caution lamp and troll mode.



White

34200-93J51-000
DF40A-200A



Black

34200-93J40-000
DF40A-200A

TRIM GAUGE

Magnetic-type gauge shows trim angle for optimum performance and efficiency.



White

34800-93J13-000
DF25A-DF250



Black

34800-93J00-000
DF25A-DF250

HOUR METER

Powered by a 12-volt electric motor, this meter shows how many hours' operation your outboard has completed, so you can tell precisely when routine maintenance and servicing is required.



White

34500-93J13-000
DF8A-DF250 DT30/40



Black

34500-93J00-000
DF8A-DF250 DT30/40

WATER-PRESSURE GAUGE

Bourdon-tube type gauge measures cooling-water pressure.



White

34650-93J33-000
DF40A-DF250



Black

34650-93J20-000
DF40A-DF250

FUEL GAUGE

Simple and easy to read for peace of mind on the water.



White

34300-93J13-000
DF8A-DF250



Black

34300-93J02-000
DF8A-DF250

VOLT METER

Monitors the charging system to help keep your outboard motor running at its best.



White

34600-93J13-000
DF8A-DF250 DT30/40



Black

34600-93J02-000
DF8A-DF250 DT30/40

SPEEDOMETER

Bourdon-tube type speedometer with readings in km/h and knots. Includes vinyl tube, hardware and installation manual.



White

34100-93J13-000

Line Up:80-130km/h
50-80 mph
45-60 knots



Black

34100-93J02-000

OPERATION SYSTEMS

GAUGES

Multi-Function Gauge – SMG4

When you're on the water, it's vital that you can get the information you need, about your engine's condition and performance whenever you need it. That's exactly the thinking behind our Suzuki Multi-Function Gauge.

ALL THE INFORMATION IN ONE PLACE

This brilliantly simple technology gives you the right information, at the right time, all on one user friendly, highly intuitive screen. You can view a wide range of important information, including engine rpm, speed and trim angle, as well as engine temp and fuel economy in 13 different measurement units and total fuel flow for multiple engine installations. You'll also receive alerts from the engine's sensors and warning systems.

All you need for effortless and relaxing boating, in one simple, reassuring and reliable device.

ANALOGUE TACHO & SPEED MODE

Engine rpm

Engine position

Ground or water

Speed*

Trim

Fuel economy

Fuel

Warning Indicator

* Speed sensor or GPS module will be required in order to display the speed.

Shift

Time

TACHO MODE

- Fuel flow (instantaneous)
- Mileage (instantaneous and average)
- Trip time, trip distance
- Engine hour, voltage, water temp and more ...

DISPLAY MODES

You can operate your Multi-Function Gauge in either digital or analogue display mode, depending on which you prefer. Plus the day and night settings

mean you can use it at literally any time. You can also zoom in on individual elements of the display, making it even easier to use.

ANALOGUE TACHO & SPEED MODE



ANALOGUE SPEED MODE (NIGHT)



ANALOGUE TACHO MODE



DIGITAL TACHO & SPEED MODE



DIGITAL TACHO MODE (NIGHT)



FUEL MODE



NEW TROLL MODE FUNCTION

- Allows you to control your troll mode from the Multi-Function Gauge.

This function is available from year 2019 models (DF200-250 excluded). Can only be used by models which are adapted to troll mode.





OPERATION SYSTEMS

NEW MULTI-FUNCTION DISPLAY

Connected to Earth

The all new Multi-Function Display and its features offers you access to all the information you need to be assured for a comfortable and Ultimate boating experience. Coming in 2019.

ULTIMATE CONNECTIVITY

With the Multi-Function Display your boat and engine can now be connected to global weather and be in touch with your surrounding environment, as well as control and operate all your other devices on your boat.

Control at the touch of a finger with the touch screen glass top design. Available in 7", 9", 12" and 16" inch screens.





KEY BENEFIT

The Suzuki Multi-Function Display gives you access to all your Suzuki engine information, so you can easily and quickly see the performance of your outboard/s in one clear view.



DIGITAL SWITCHING

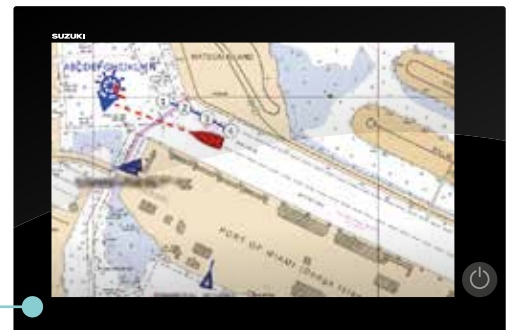
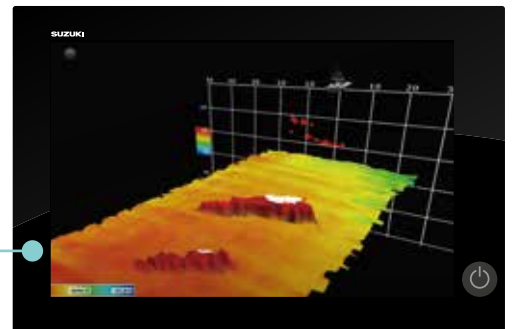
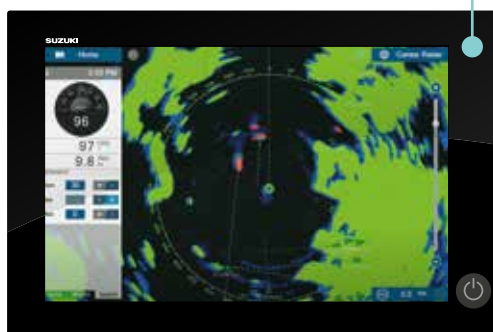

CHART PLOTTER



MULTI BEAM SONAR



RADAR



WEATHER



OPERATION SYSTEMS

NEW MULTI-FUNCTION DISPLAY Customising your display – SMD16 & SMD12

Big screen navigation for large boats. The 16" and 12" allow you to choose the screen size that best matches your helm or bridge needs. You can build your system with the best sensors and technologies to suit your needs. Coming in 2019.



SMD16



SMD12

*Supplied by FURUNO

FISH FINDER

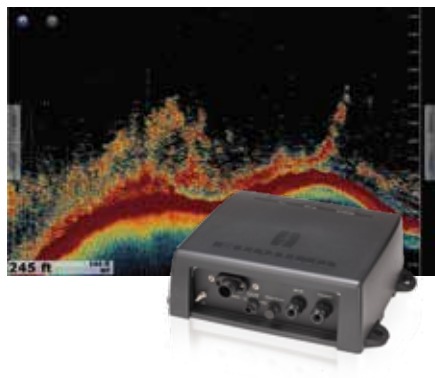

BBDS1 Bottom Discrimination Sounder

- Enhanced detection of fish echoes using FURUNO Digital Filter (DFD™) Fish Finder technology
- Dual frequency, 50 kHz and 200 kHz

DFF1-UHD Network TruEcho CHIRP™ Fish Finder

- TruEcho CHIRP™ technology
- Designed to operate over a broadband range of frequencies utilising a broadband transducer
- Clear presentation separates bottom structure from bottom fish, and bait fish from game fish

DFF3 Network Fish Finder

- Enhanced detection of fish echoes using FURUNO Digital Filter (DFD™) Fish Finder technology
- FURUNO Free Synthesiser transceiver to let you choose any two operating frequencies from 28 to 200 kHz

	BBDS1	DFF1-UHD	DFF3
Display Modes	Single (50 or 200 kHz), Dual (50 and 200 kHz), Bottom-lock, Bottom-Zoom, ACCU-FISH™, Bottom Discrimination, A-scope	Single (High or Low frequency), Dual (Both High and Low frequencies), Bottom-lock, Bottom-Zoom, ACCU-FISH™, Bottom Discrimination, A-Scope	Single (high or low), Dual (high and low), Bottom-lock, Bottom-Zoom, ACCU-FISH™, A-scope * With Transducer (50/200-1T) only.
Range Scale	Max. 1,200 m	Max. 1,200 m	Max. 3,000 m
Power Supply	12-24 VDC, 12 W, 1.1-0.4 A	12-24 VDC, 30 W, 2.8-1.4 A	12-24 VDC, 30 W, 3.5 A
Transducers	600 W/1 kW*, 50/200 kHz * Optional Matching Box, MB-1100 may be required.	1 kW, Broadband transducers 42-65 kHz (low), 130-210 kHz (high)	1/2/3 kW, Frequency: 28, 38, 50, 68, 82, 88, 107, 150, 200 kHz, 50/200 kHz

SONAR

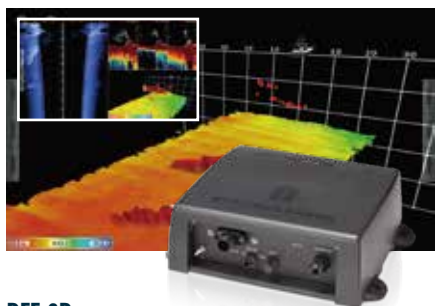

DFF-3D Network Multi Beam Sonar

- Sidebar detection range is up to 200 m in a 120-degree swath port and starboard direction*
- Deep water, main beam penetration directly under the boat is approx. 300 m*

* Maximum depth depending on installation, bottom type and water conditions.

Display Modes	Cross Section, Triple/Single Beam Sounder, Side Scan, 3D Sounder History
Range Scale	Max. 1,200 m
Power Supply	12-24 VDC, 1.4-0.7 A
Transducers	800 W, 2 types (thru-hull and transom mount)

RADAR



DRS4D-NXT/DRS6A-NXT Solid State Radar Sensor

- Solid-State pulse compression Doppler Radar
- Revolutionary Target Analyzer™ function instantly identifies hazardous targets
- Fast Target Tracking™ and Auto Target Acquire function, up to 100 targets
- Bird Mode to find the best fishing grounds by tracking birds

Peak Output Power	Solid-state, 25 W
Type	DRS4D-NXT: ø610 mm Radome (24"), DRS6A-NXT: 1036 mm Open (3.5")/1255 mm Open (4")/1795 mm Open (6")
Antenna Rotation Speed	24*/36/48 rpm range coupled or 24 rpm fixed * In dual range mode, speed is limited to 24 rpm.
Power Supply	12-24 VDC, DRS4D-NXT: 2.5-1.3 A, DRS6A-NXT: 9.5-5.0A



DRS6A X-CLASS Radar Sensor

- Enhanced target detection, both short and long range
- Bird mode helps you identify birds, adjusting the gain and sea settings automatically for optimal visibility
- Fast Target Tracking™, takes only seconds for a speed and course vector to be displayed

Peak Output Power	6 kW
Type	1036 mm Open (3.5")/1255 mm Open (4")/1795 mm Open (6")
Antenna Rotation Speed	24/36/48 rpm range coupled or 24 rpm fixed
Power Supply	24 VDC, 4 A

AIS RECEIVER



FA-30

- Enhances navigation by receiving critical navigation information from local AIS-equipped vessels

Power Supply	12-24 VDC, 1.2-0.6 A
--------------	----------------------

VHF RADIO TELEPHONE



FM-4800

VHF RadioTelephone with built-in AIS Receiver

- Built-in AIS Receiver for situational awareness and collision avoidance
- Built-in 72 channels GPS Receiver
- 25 W/1 W output power
- Class D DSC with Distress, Individual and All Ship calls
- 30 W PA/Loud Hailer with automatic fog signals and listen back

AIS Receiver	Receiving Frequency (CH): 161.975 MHz (AIS1), 162.025 MHz (AIS2)
Output Power	Transmitter: 25 W max., 1 W at power reduction. Loud Hailer/Fog Horn: 30 W max. (4 ohm)
Power Supply	12 VDC (-10% to +30%), 5.0 A max.

SATELLITE COMPASS / HEADING SENSOR



SC-33 Satellite Compass™

- Provides highly accurate heading data for Autopilot, Radar, and Chart Plotter



PG-700 Integrated Heading Sensor

- Provides heading data of high accuracy
- Black box type fluxgate magnetic sensor
- CAN bus interface incorporated



PG-500 Integrated Heading Sensor

- Inexpensive heading sensor with the highest accuracy and stability in this class of equipment
- High stability for a solid-state rate gyroscope

	SC-33	PG-700	PG-500
Heading Accuracy	0.4° rms	±1.0° (horizontal)	±1.0° (horizontal)
Heading Resolution	0.1°	0.1°	0.1°
Port	NMEA2000:1 Port	CAN bus: 1	Input: 1, Output: 2 ports (one port drives 3 outputs)
Power Supply	12-24 VDC: 0.4-0.2 A, LEN11	12 VDC: 0.1 A (LEN: 3)	12-24 VDC: 120-30 mA



OPERATION SYSTEMS

NEW MULTI-FUNCTION DISPLAY

Customising your display – SMD9 & SMD7

Powerful technology in a compact design that is compact enough to fit on small runabouts and centre consoles. The 9" and 7" touch screens enable you to operate the chart plotter with built-in fish finder at the touch of a finger. Coming in 2019.



SMD9



SMD7

*Supplied by FURUNO

RADAR

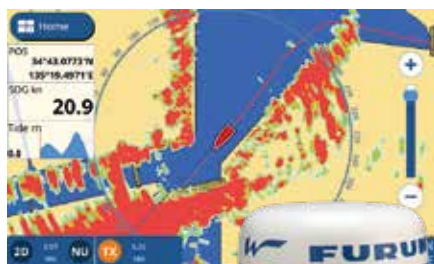

DRS4W 1st Watch Wireless Radar

- 4 kW Radar antenna, powerful yet compact in size
- Wireless LAN, no extra wiring needed except the power source, making installation a breeze.



Peak Output Power	4 kW
Type	ø488 mm Radome (19°)
Antenna Rotation Speed	24 rpm
Power Supply	12-24 VDC, 2.1-1.0 A max.

AIS RECEIVER



FA-30

- Enhances navigation by receiving critical navigation information from local AIS-equipped vessels

Power Supply	12-24 VDC, 1.2-0.6 A
--------------	----------------------

VHF RADIO TELEPHONE

FM-4800 VHF RadioTelephone with built-in AIS Receiver



- Built-in AIS Receiver for situational awareness
- Built-in 72 channels GPS Receiver
- 25 W/1 W output power
- Class D DSC with Distress, Individual and All Ship calls
- 30 W PA/Loud Hailer with automatic fog signals and listen back

AIS Receiver	Receiving Frequency (CH): 161.975 MHz (AIS1), 162.025 MHz (AIS2)
Output Power	Transmitter: 25 W max., 1 W at power reduction. Loud Hailer/Fog Horn: 30 W max. (4 ohm)
Power Supply	12 VDC (-10% to +30%), 5.0 A max.

SATELLITE COMPASS / HEADING SENSOR



SC-33 Satellite Compass™

- Provides highly accurate heading data for Autopilot, Radar, and Chart Plotter



PG-700 Integrated Heading Sensor

- Provides heading data of high accuracy
- Black box type fluxgate magnetic sensor
- CAN bus interface incorporated



PG-500 Integrated Heading Sensor

- Inexpensive heading sensor with the highest accuracy and stability in this class of equipment
- High stability for a solid-state rate gyroscope

	SC-33	PG-700	PG-500
Heading Accuracy	0.4° rms	±1.0° (horizontal)	±1.0° (horizontal)
Heading Resolution	0.1°	0.1°	0.1°
Port	NMEA2000:1 Port/NMEA2000:1 Port	CAN bus: 1	Input: 1, Output: 2 ports (one port drives 3 outputs)
Power Supply	12-24 VDC: 0.4-0.2 A, LEN11	12 VDC: 0.1 A (LEN: 3)	12-24 VDC: 120-30 mA

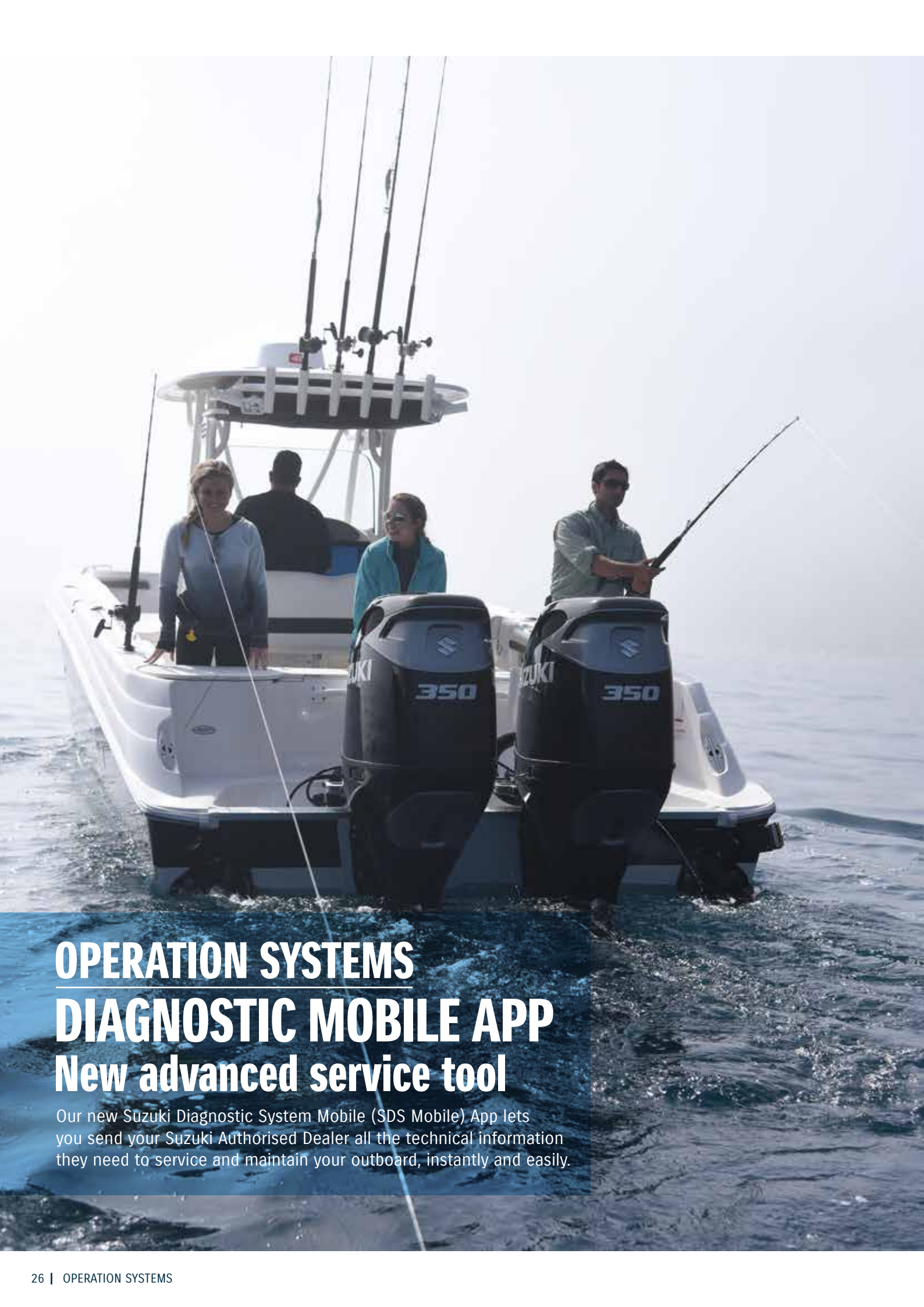

OPERATION SYSTEMS

DIAGNOSTIC MOBILE APP

New advanced service tool

Our new Suzuki Diagnostic System Mobile (SDS Mobile) App lets you send your Suzuki Authorised Dealer all the technical information they need to service and maintain your outboard, instantly and easily.

SDS Mobile works in tandem with our new Multi-Function Gauge and new Multi-Function Display. Simply download the App, which is available on iOS and Android, to your smartphone: you don't need a separate device.

When you email your QR code to the Dealer the data will be transferred directly - including engine number, number of hours since the last oil change and total hours of operation at different rpm.



DOWNLOAD THE APP FROM:



Apple and the Apple logo are trademarks of Apple Inc., registered in the U.S. and other countries. App Store is a service mark of Apple Inc., registered in the U.S. and other countries.

Google Play and the Google Play logo are trademarks of Google LLC.

SDS Mobile App and email service is entirely free of charge.

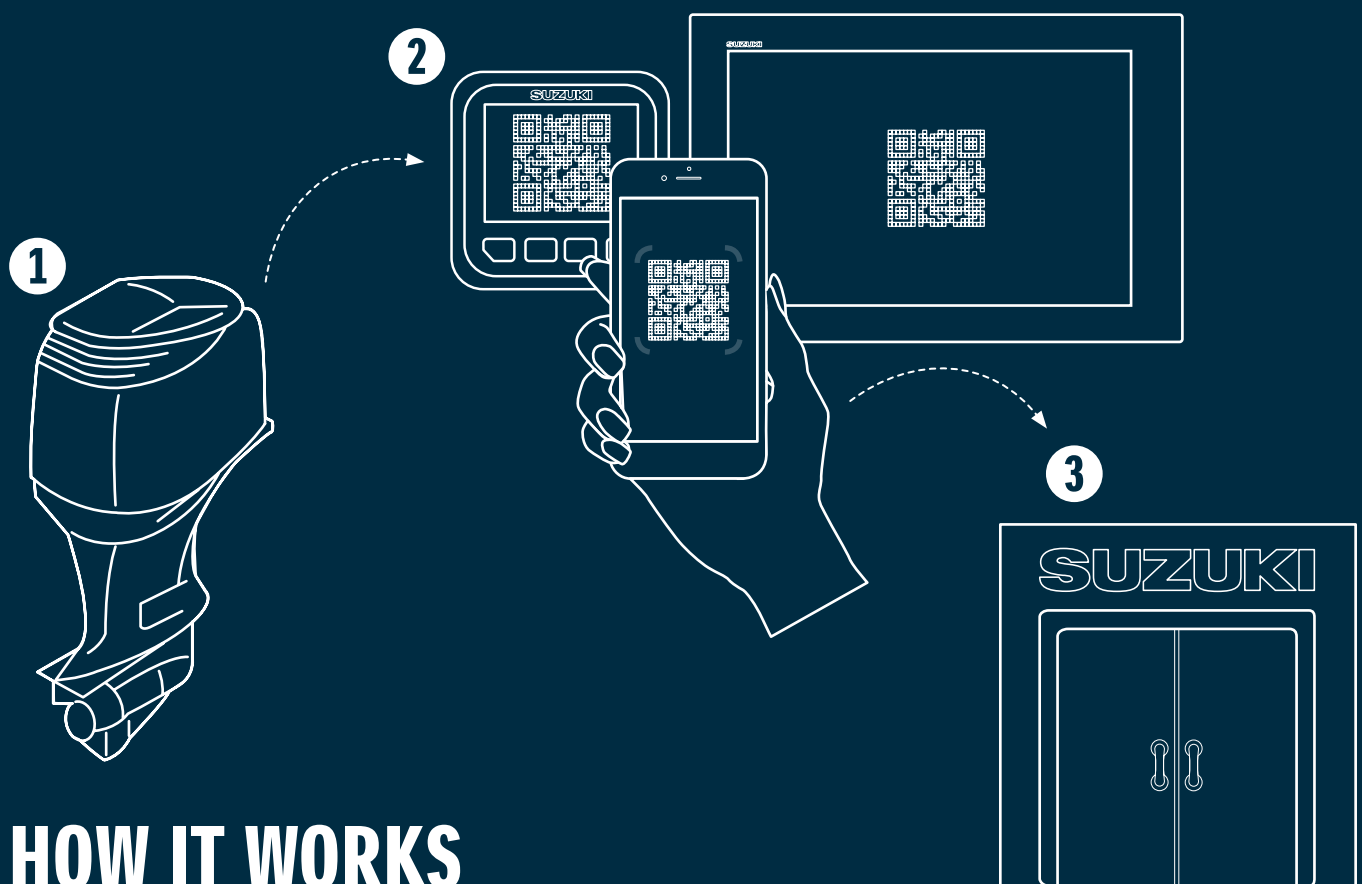

HOW IT WORKS

1. The Outboard sends engine data and converts it into a QR code displayed on the Multi-Function Gauge or Multi-Function Display.
2. With the SDS Mobile App, you can then scan the QR code on the Multi-Function Gauge or Multi-Function Display with your phone. The engine data will be stored on your smartphone.
3. You can then send the engine data via email to your Suzuki Dealer.



OPERATION SYSTEMS

KEYLESS START SYSTEM

World-first outboard technology

Our industry-first Keyless Start System lets you start your outboard without inserting a key. It means you'll never risk losing a key overboard again. With the key-fob in your pocket, just stand within a metre of the console, turn on the main switch, press the start button and you're ready to go.



The system works by transmitting a unique access code from the key-fob to the engine's starting system. Without the key-fob, the engine won't start, making it a completely effective theft

deterrent. And for total peace of mind, we've even designed the key-fob to float, so if you're unlucky enough to drop it overboard, you can easily retrieve it.



Find out more by watching our videos

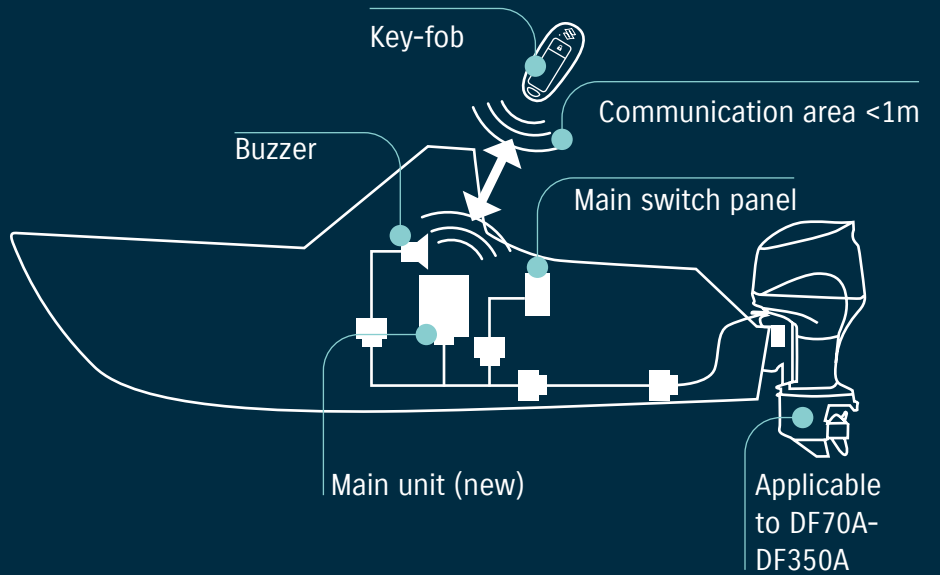

2 SUZUKI PROPELLERS

TOUGH. DURABLE. DEPENDABLE.







SUZUKI PROPELLERS

WATERGRIP

Ultimate power delivery

All Suzuki propellers are designed specifically for your outboard to give outstanding performance for long reliable and trouble free service. Made from stainless steel they are incredibly hard wearing making them durable, dependable and fit for purpose.

To get the best from your outboard we have launched a new series of propellers. Our very first propeller brand: WATERGRIP.

THE NEW

WATERGRIP RANGE

WATERGRIP is a new stainless-steel propeller series offering accurate response to your operation. With efficient conversion of engine power into propulsion, this propeller series meets our customers' demand for bigger, faster, more powerful outboards.

The WATERGRIP propeller series employs a new interchangeable and square shaped propeller bush that minimises power loss in delivery.

PROPELLER BUSH ADVANTAGES

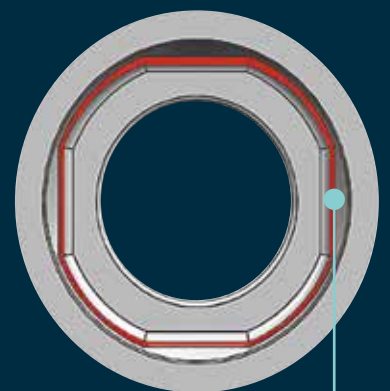

- Better resistance over propeller slip
- Interchangeable bush

WATERGRIP

The WATERGRIP series will be the new standard for Suzuki propellers. The new interchangeable and square shaped bush system is designed not only to be replaced easily and quickly when required, but also to accurately and efficiently convert power from the engine to thrust through the propeller.

As a result, you will be able to enjoy more time having the ultimate experience on the water rather than waiting for repairs on the land.



WATERGRIP DUAL

Our new flagship models, the DF350A and DF325A, introduced the Suzuki Dual Prop System, an industry-leading technology that is truly a revolution in innovation. Big engines demand more efficient conversion of engine output into propulsion.

With two contra-rotating propellers operating simultaneously, the conversion efficiency becomes greater as does stability, grip and manoeuvrability. The end-result is that the Suzuki Dual Prop System delivers outstanding and exciting performance.



WATERGRIP SPORT

In addition to ease of maintenance and efficiency of power conversion, the WATERGRIP SPORT propellers feature a high rake blade design, which delivers excellent acceleration and exceptional top speed. These propellers are ideal for lightweight sports boats as they give remarkably stable thrust when turning which results in superior manoeuvrability and lots of fun boating.



COMING IN 2019

PROPELLER RANGE

MODEL	TYPE	MATERIAL	BLADE	DIAMETER	PITCH	ROTATION*	DESCRIPTION	PART NUMBER
DF2.5	A520	Aluminum	3	7 3/8	5 3/8	RR		58110-97JA0-019
DF4A	C601	Aluminum	3	7 1/2	6	RR		58110-91JL0-019
DF5A	C611	Aluminum	3	7 1/2	6 1/2	RR		58110-91JM0-019
DF6A	C701	Aluminum	3	7 1/2	7	RR		58110-91JN0-019
DF8A	M701	Aluminum	3	9 1/4	7	RR		58100-89L00-019
DF9.9A	M821	Aluminum	3	9 1/4	8	RR	THICK	58100-90L40-019
	M901	Aluminum	3	9 1/4	9	RR		58100-89L20-019
	M911	Aluminum	3	9 1/4	9	RR	THICK	58100-90L50-019
	M1001	Aluminum	3	9 1/4	10	RR		58100-89L60-019
	M1011	Aluminum	3	9 1/4	10	RR	THICK	58100-90L21-019
	M1101	Aluminum	3	9 1/4	11	RR		58100-89L70-019
DF9.9B		Aluminum	4	10	5	RR	High thrust	58100-94JA1-019
DF15A		Aluminum	4	10	7	RR	High thrust	58100-94JB0-019
DF20A		Aluminum	3	9-1/4	7	RR		58100-89L00-019
DT9.9A		Aluminum	3	9-1/4	8	RR	THICK	58100-90L41-019
DT15A		Aluminum	3	9-1/4	9	RR		58100-89L20-019
		Aluminum	3	9-1/4	9	RR	THICK	58100-90L50-019
		Aluminum	3	9-1/4	10	RR		58100-89L60-019
		Aluminum	3	9-1/4	10	RR	THICK	58100-90L60-019
		Aluminum	3	9-1/4	11	RR		58100-89L70-019
		Aluminum	3	9-1/4	12	RR		58100-89L50-019
DF25A	P911	Aluminum	3	10 1/4	9	RR	THICK	58100-96372-019
DF30A	P1001	Aluminum	3	10 1/4	10	RR		58100-91L40-019
	P1011	Aluminum	3	10 1/4	10	RR	THICK	58100-96472-019
	P1101	Aluminum	3	10 1/4	11	RR		58100-91L50-019
	P1201	Aluminum	3	10 1/4	12	RR		58100-91L20-019
	P1211	Aluminum	3	10 1/4	12	RR	THICK	58100-96482-019
	P1301	Aluminum	3	10 1/4	13	RR		58100-91L30-019
	P1311	Aluminum	3	10 1/4	13	RR	THICK	58100-96492-019
	P1401	Aluminum	3	10 1/4	14	RR		58100-95D01-019
	P1501	Aluminum	3	10 1/4	15	RR		58100-96462-019
DF40A	S900	Aluminum	3	11 1/2	9	RR		58100-88L03-019
DF50A	S1000	Aluminum	3	11 1/2	10	RR		58100-88L13-019
DF60A	S1100	Aluminum	3	11 1/2	11	RR		58100-88L23-019
	S1200	Aluminum	3	11 5/8	12	RR		58100-88LA0-019
	S1301	Aluminum	3	11 1/2	13	RR		58100-88LB0-019
	S1400	Aluminum	3	11 3/8	14	RR		58100-88L52-019
	S1500	Aluminum	3	11 1/4	15	RR		58100-88L62-019
	S1600	Aluminum	3	11 1/8	16	RR		58100-88L72-019
	S1700	Aluminum	3	11	17	RR		58100-88L83-019
	SS1600	Stainless	3	11 1/8	16	RR		58200-88L30-000
DF50AV		Aluminum	3	14	9	RR		58100-87LG1-019
DF60AV		Aluminum	3	14	11	RR		58100-87LH0-019
		Aluminum	3	13 3/4	12	RR		58100-87LI0-019
		Aluminum	3	14	13	RR		58100-87LA0-019
		Aluminum	3	13 7/8	15	RR		58100-87LB0-019
		Aluminum	3	13 3/4	17	RR		58100-87LC0-019
DF70A		Aluminum	3	14	13	RR		58100-87LA0-019
DF80A		Aluminum	3	13 7/8	15	RR		58100-87LB0-019
DF90A		Aluminum	3	13 3/4	17	RR		58100-87LC0-019
DF100B		Aluminum	3	13 3/4	19	RR		58100-87LD0-019
		Aluminum	3	13 3/4	21	RR		58100-87LE0-019
		Aluminum	3	13 3/4	23	RR		58100-87LF0-019
		Aluminum	3	13 1/2	15	RR		58100-90JE0-019
		Aluminum	3	14	17	RR		58100-90JA0-019
		Aluminum	3	14	19	RR		58100-90JB0-019
		Aluminum	3	14	21	RR		58100-90JC0-019
		Aluminum	3	14	23	RR		58100-90JD0-019
		Stainless	3	13 7/8	15	RR		58200-92J40-000
		Stainless	3	13 7/8	17	RR		58200-92J50-000
		Stainless	3	13 7/8	19	RR		58200-92J60-000
		Stainless	3	13 7/8	21	RR		58200-92J70-000
		Stainless	3	13 7/8	23	RR		58200-92J80-000
		Stainless	3	13 7/8	25	RR		58200-92J90-000

*RR:Regular-Rotation model, CR:Counter-Rotation model

MODEL	TYPE	MATERIAL	BLADE	DIAMETER	PITCH	ROTATION*	DESCRIPTION	PART NUMBER
DF100A		Aluminum	3	13 1/2	15	RR		58100-90JE0-019
DF115A		Aluminum	3	14	17	RR		58100-90JA0-019
DF140A		Aluminum	3	14	19	RR		58100-90JB0-019
		Aluminum	3	14	21	RR		58100-90JC0-019
		Aluminum	3	14	23	RR		58100-90JD0-019
		Stainless	3	13 7/8	15	RR		58200-92J40-000
		Stainless	3	13 7/8	17	RR		58200-92J50-000
		Stainless	3	13 7/8	19	RR		58200-92J60-000
		Stainless	3	13 7/8	21	RR		58200-92J70-000
		Stainless	3	13 7/8	23	RR		58200-92J80-000
		Stainless	3	13 7/8	25	RR		58200-92J90-000
		Stainless	3	13 7/8	17	CR		58200-92JA0-000
		Stainless	3	13 7/8	19	CR		58200-92JB0-000
		Stainless	3	13 7/8	21	CR		58200-92JC0-000
		Stainless	3	13 7/8	23	CR		58200-92JD0-000

DF150A	Watergrip Standard	Stainless	3	16	15	RR		58700-93L80-000
DF150AP	Watergrip Standard	Stainless	3	16	17	RR		58700-93L00-000
DF175A	Watergrip Standard	Stainless	3	16	18 1/2	RR		58700-93L10-000
DF175AP	Watergrip Standard	Stainless	3	16	20	RR		58700-93L20-000
DF200	Watergrip Standard	Stainless	3	16	21 1/2	RR		58700-93L30-000
DF200A	Watergrip Standard	Stainless	3	16	23	RR		58700-93L40-000
DF200AP	Watergrip Standard	Stainless	3	16	24 1/2	RR		58700-93L50-000
DF225	Watergrip Standard	Stainless	3	16	26	RR		58700-93L60-000
DF250	Watergrip Standard	Stainless	3	16	27 1/2	RR		58700-93L70-000
DF250AP	Watergrip Standard	Stainless	3	16	17	CR		58800-93L00-000
DF300AP	Watergrip Standard	Stainless	3	16	18 1/2	CR		58800-93L10-000
	Watergrip Standard	Stainless	3	16	20	CR		58800-93L20-000
	Watergrip Standard	Stainless	3	16	21 1/2	CR		58800-93L30-000
	Watergrip Standard	Stainless	3	16	23	CR		58800-93L40-000
	Watergrip Standard	Stainless	3	16	24 1/2	CR		58800-93L50-000
	Watergrip Standard	Stainless	3	16	26	CR		58800-93L60-000
	Watergrip Standard	Stainless	3	15 1/2	17	RR		58700-96J00-000
	Watergrip Standard	Stainless	3	15 1/4	19	RR		58700-96J10-000
	Watergrip Standard	Stainless	3	15	21	RR		58700-96J20-000
	Watergrip Standard	Stainless	3	14 3/4	23	RR		58700-96J30-000
	Watergrip Standard	Stainless	3	14 1/2	25	RR		58700-96J40-000
	Watergrip Standard	Stainless	3	14 1/2	27	RR		58700-96J50-000
	Watergrip Standard	Stainless	3	15 1/2	17	CR		58800-96J00-000
	Watergrip Standard	Stainless	3	15 1/4	19	CR		58800-96J10-000
	Watergrip Standard	Stainless	3	15	21	CR		58800-96J20-000
	Watergrip Standard	Stainless	3	14 3/4	23	CR		58800-96J30-000
	Watergrip Standard	Stainless	3	14 1/2	25	CR		58800-96J40-000
	Watergrip Standard	Stainless	3	14 1/2	27	CR		58800-96J50-000
	Watergrip Standard	Stainless	4	15 1/4	18	RR		58700-93J00-000
	Watergrip Standard	Stainless	4	15 1/4	20	RR		58700-93J10-000
	Watergrip Standard	Stainless	4	15 1/4	22	RR		58700-93J20-000
	Watergrip Standard	Stainless	4	15 1/4	24	RR		58700-93J30-000
	Watergrip Standard	Stainless	4	15 1/4	26	RR		58700-93J40-000
	Watergrip Standard	Stainless	4	15 1/4	20	CR		58800-93J10-000
	Watergrip Standard	Stainless	4	15 1/4	22	CR		58800-93J20-000
	Watergrip Standard	Stainless	4	15 1/4	24	CR		58800-93J30-000
	Watergrip Standard	Stainless	4	15 1/4	26	CR		58800-93J40-000

DF325A/ DF350A	Watergrip Dual	Stainless	3	15 1/2	12			58500-98LA0-000	
								58600-98LA0-000	
	Watergrip Dual	Stainless	3	15 1/2	15				58500-98LB0-000
									58600-98LB0-000
	Watergrip Dual	Stainless	3	15 1/2	16.5				58500-98LC0-000
									58600-98LC0-000
	Watergrip Dual	Stainless	3	15 1/2	18				58500-98L90-000
									58600-98L90-000
	Watergrip Dual	Stainless	3	15 1/2	19.5				58500-98L60-000
									58600-98L60-000
	Watergrip Dual	Stainless	3	15 1/2	21				58500-98L00-000
									58600-98L00-000
	Watergrip Dual	Stainless	3	15 1/2	22.5				58500-98L10-000
									58600-98L10-000
	Watergrip Dual	Stainless	3	15 1/2	24				58500-98L20-000
									58600-98L20-000
	Watergrip Dual	Stainless	3	15 1/2	25.5				58500-98L30-000
									58600-98L30-000
	Watergrip Dual	Stainless	3	15 1/2	27				58500-98L40-000
									58600-98L40-000
	Watergrip Dual	Stainless	3	15 1/2	28.5				58500-98L50-000
									58600-98L50-000
	Watergrip Dual	Stainless	3	15 1/2	30				58500-98L70-000
									58600-98L70-000
Watergrip Dual	Stainless	3	15 1/2	31.5				58500-98L80-000	
								58600-98L80-000	

3

**UTILITY
EQUIPMENT**

EASY. FLEXIBLE. ESSENTIAL.







UTILITY EQUIPMENT

THE SUZUKI RANGE

Customising your outboard

Our utility equipment range makes it easy to customise your outboard to suit your individual boating needs and preferences. You have a huge choice of options, from integrated tiller handles, steering extension and extra fuel line systems to flush hose attachments, engine covers and rigging tube – all designed and manufactured by Suzuki specifically for our outboards and to our exacting engineering standards. For more information about the full range, please ask your local Authorised Suzuki Dealer.



FUEL TANK



**WATER SEPARATOR /
FUEL FILTER**



ENGINE COVER



FUEL HOSE



ELEMENT SET



RIGGING TUBE



CARRIERBAG



**INTEGRATED MULTI-FUNCTION
TILLER HANDLE KIT**



The integrated Multi-Function Tiller Handle Kit utilises the functions that are essential for your drive. Tachometer, warning indicator, Troll Mode switch, power trim and grip friction adjuster together with normal tiller handle function.

63002-88L22-YAY
DF40A/50A

63002-88L14-YAY
DF60A/50AV/60AV



Tachometer with warning indicators



Three-position angle adjustable bracket

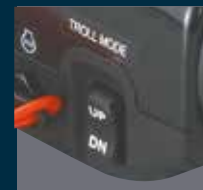

Troll mode switch activates Suzuki Troll Mode System and controls RPM from idling engine speed up to 1200rpm at every 50rpm



Power trim and tilt switch and throttle grip friction adjuster

63002-87L15-YAY
DF70A-90A

63002-90J33-YAY
DF 100A/115A

4

MAINTAINING YOUR SUZUKI

PROTECT. MAINTAIN. SECURE.







MAINTAINING YOUR SUZUKI FOR PEACE OF MIND

Keep your Suzuki 100% Suzuki

Regular maintenance is essential to keep your outboard running smoothly and reliably. Different components require maintenance or replacement at different intervals, and you may find you don't always have the right part at the right time.

CHEMICALS

Like our engine oils, our Suzuki Approved Genuine chemicals are fully factory tested, and specifically engineered to ensure your Suzuki outboard runs smoothly and reliably.



ANODES

Anodes protect your outboard from corrosion, extending its service life. We have a complete range of anodes to protect your outboard from the effects of fresh, salt and brackish water. Please ask your Suzuki Dealer for further information.



MAGNESIUM ANODE
for freshwater



ZINC ANODE
for saltwater



ALUMINUM ANODE
for brackish water

MAINTENANCE KITS



Suzuki Maintenance Kits, available for all Suzuki outboards from portable to high horsepower models, are designed to make life easier for you and your Authorised Suzuki Dealer as they contain all the Suzuki Genuine Parts your Dealer needs to keep your engine fully serviced.

All our parts are rigorously tested for performance, quality, durability and safety. Best of all, it works out around 10% cheaper than buying all the parts individually.

KIT NAME/MODEL	PART NUMBER	YEAR
DF2 / 2.5	17400-97820-000	06-11
DF2 / 2.5	17400-97810-000	12-
DF4 / 5 / 6	17400-91860-000	02-10
DF4 / 5 / 6	17400-91830-000	11- 16
DF4A / 5A / 6A	17400-91890-000	17-
DF8A / 9.9A	17400-99840-000	10-
DF9.9 / 15	17400-94810-000	11-13
DF9.9B / 15A / 20A	17400-89810-000	13-
DF20 / 25 V2	17400-95870-000	06-
DF25 / 30	17400-89820-000	01-10
DF25A / 30A	17400-94820-000	15-
DF40 / 50	17400-87820-000	06-10
DF40A / 50A / 60A	17400-88810-000	10-
DF50AV / 60AV	17400-88820-000	14-
DF60	17400-99850-000	09
DF60 / 70	17400-99870-000	07
DF60 / 70	17400-99860-000	08-09
DF70A / 80A / 90A	17400-87810-000	09-
DF100 / 115	17400-92840-000	10-12
DF100B	17400-87830-000	18
DF100A / 115A / 140A	17400-92821-000	13-
DF140	17400-92850-000	10-12
DF150 / 175	17400-96821-000	06-
DF150AP / 175AP / 200AP	17400-96831-000	16-
DF200 / 225 / 250	17400-93852-000	11-
DF250A / 300(A) / 250S	17400-98862-000	11-
DF350A / 325A	17400-98870-000	18

MAINTAINING YOUR SUZUKI ECSTAR OIL

The ultimate formulation

In the 1980's, Suzuki started the development of lubricants in pursuit of the ultimate performance. The lubricant is named "Ecstar" as it is our guiding "Star" towards an "Ecstatic" performance. As the expectation towards our products evolves, the same attention to performance is required for durability and environmental protection. With the high technology cultivated through its long history and dedicated engineering, Suzuki has precisely reformulated "ECSTAR" to satisfy and exceed these requirements.

By enhancing and drawing out the best performance, "ECSTAR" will give you a Suzuki experience that others could not.

ECSTAR V7000

Suzuki engineers have created a premium oil that has not only exceeded all standards set by the NMMA but more importantly has been designed specifically for Suzuki marine engines. ECSTAR is FC-W equivalent and uses a high quality low sulfur content based oil that reduces ash buildup for increased durability and the high viscosity index is a major contributor to maximising fuel efficiency.

ECSTAR V7000 SEMI SYNTHETIC MARINE ENGINE OIL

High performance blend of synthetic lubricants and premium mineral oils engineered to protect your Suzuki engine and optimise its performance.

- Less engine water
- Lower oil consumption
- Improved starting
- Reduced fuel consumption

SUZUKI
ECSTAR
SUZUKI GENUINE OIL





ADVANTAGE OF ECSTAR



FUEL SAVINGS

The Genuine formulation creates the high performance and meets the severest fuel economy standards for Suzuki engines.



CLEAN ENGINE

Cleaning performance extends the engine life by preventing sludge and deposits. The engine stays trouble-free.



ENGINE PROTECTION

The innovative lubricating technology achieves the thermal stability, which delivers the ultimate engine protection even when starting engine in cold climates.

MAINTAINING YOUR SUZUKI

GENUINE OIL

Suzuki approved

Suzuki approved top quality oils that have been rigorously tested and are specifically designed to help keep your Suzuki outboard in tip top condition.



4-STROKE ENGINE OIL (FC-W)

SAE VISCOSITY GRADE: 10W-30



4-STROKE ENGINE OIL (FC-W)

SAE VISCOSITY GRADE: 10W-40

This 4-stroke outboard oil is a unique blend of top-quality oil and special additives, giving outstanding wear protection, viscosity stability, low volatility and excellent protection from corrosion.



RECOMMENDED

Our Suzuki Approved Genuine engine oils have all been rigorously tested and certified by Suzuki engineers. So you can be confident that they'll help keep your Suzuki outboard in perfect condition, giving you maximum performance and reliability over its lifetime.

API Classification	SAE Viscosity Grade																
SG																	
SH																	
SL																	
SJ																	
SM																	
Temp.	<table border="1"> <tr> <td>C</td> <td>-20</td> <td>-10</td> <td>0</td> <td>10</td> <td>20</td> <td>30</td> <td>40</td> </tr> <tr> <td>F</td> <td>-4</td> <td>14</td> <td>32</td> <td>50</td> <td>68</td> <td>86</td> <td>104</td> </tr> </table>	C	-20	-10	0	10	20	30	40	F	-4	14	32	50	68	86	104
C	-20	-10	0	10	20	30	40										
F	-4	14	32	50	68	86	104										

SUZUKI APPROVED GENUINE OIL BY MOTUL

We've been in partnership with MOTUL in MotoGP motorcycle racing since 1988.

Building on this trusted relationship, we've worked together to develop our new Suzuki Marine Oils, which provide outstanding rust protection under the toughest operating conditions.



5 RECOMMENDED STEERING KITS

TRUSTED. EFFICIENT. SOPHISTICATED.







RECOMMENDED STEERING KITS

STEERING SYSTEMS

Hydraulic wheel steering

Order taking, delivery, technical support and warranty for these products are handled by SeaStar Solutions. Please consult your local SeaStar Solutions distributor or dealer if you need more detailed product information, price, availability and all business terms.

RECOMMENDED STEERING SYSTEM SUPPLIED BY SEASTAR SOLUTIONS



www.seastarsolutions.com

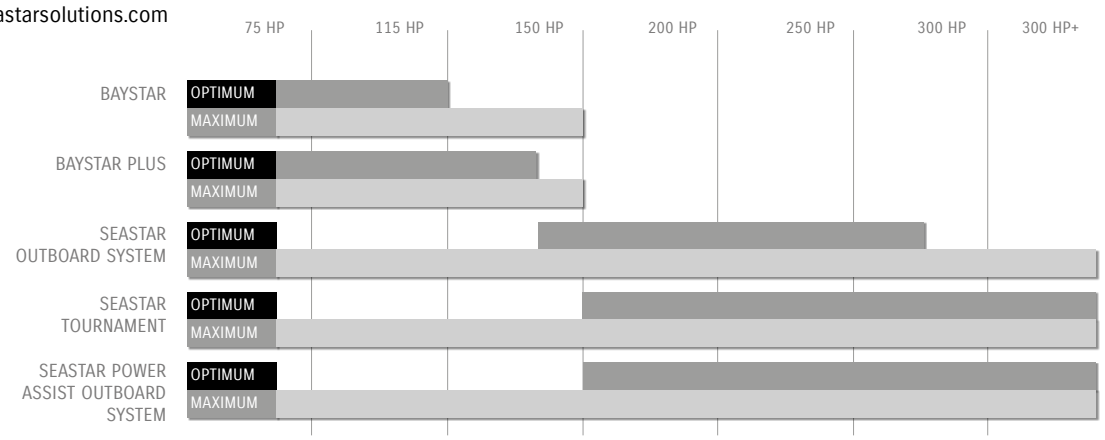

As specialists in the art of steering, SeaStar Solutions take the recommendation of steering systems very seriously especially as modern outboard engines become more powerful. Unlike other steering manufacturers we prefer to make systems recommendations based on "optimum comfort".

*For further application information please refer to www.seastarsolutions.com

STEERING KIT

BAYSTAR™



BAYSTAR

BAYSTAR OUTBOARD SYSTEM - HK4200A-3

System comprises:	
BayStar Helm 1.4cu" (22.94cc)	HH4314-3
BayStar Compact Cylinder	HC4645H*
20ft "cut to length" tubing kit	HT4420H
2 x litre SeaStar hydraulic oil	HA5430

*Note: 115-140hp four stroke 2001 to current model require HC4658H.

BAYSTAR PLUS™



BAYSTAR PLUS

BAYSTAR OUTBOARD SYSTEM - HK4500A-3

System comprises:	
BayStar Plus Helm 1.4cu" (22.94cc)	HH4514-3
BayStar Compact Cylinder	HC4645H*
2 x litre SeaStar hydraulic oil	HA5430
Note: 1 x SeaStar hose kits must be ordered separately	

*Note: 115-140hp four stroke 2001 to current model require HC4658H.

SEASTAR



SEASTAR

SEASTAR OUTBOARD SYSTEM - HK6400-3

System comprises:	
SeaStar Helm 1.7cu" (27.80cc)	HH5271-3
SeaStar Pivot Cylinder	HC5345-3*
2 x litre SeaStar hydraulic oil	HA5430
Note: 1 x SeaStar hose kits must be ordered separately	

*Note: 115-140hp 1996 only requires HC5348, 40-140hp four stroke 1998 to current model and 90hp four stroke 2003 to current model require HC5358.

SEASTAR™ PA



SEASTAR POWER ASSIST

SEASTAR OUTBOARD POWER ASSIST SYSTEM

System comprises:	
SeaStar Helm 1.7cu" (27.80cc)	HH5271-3
SeaStar Pivot Cylinder	HC5345-3*
2 x litre SeaStar hydraulic oil	HA5430
SeaStar 12v Power Assist Unit	PA1200-2
Note: 2 x SeaStar hose kits must be ordered separately	

*Note: 115-140hp 1996 only requires HC5348, 40-140hp four stroke 1998 to current model and 90hp four stroke 2003 to current model require HC5358.

SEASTAR



TOURNAMENT CYLINDER AND ADJUSTABLE TIE BAR

CONFIGURATION	CYLINDER		HARDWARE KIT		TIE BAR			
	PART NO.	QTY.	PART NO.	QTY.	PART NO.	QTY.	CENTRE TO CENTRE DISTANCE (IN)	CENTRE TO CENTRE DISTANCE (MM)
Twin Engine - Single Cylinder (STBD)	HC6845	1	HA6802	1	H06821	1	25.0 - 25.6	635 - 650
					H06822		25.7 - 30.6	653 - 777
					H06823		30.7 - 39.0	780 - 991
Twin Engine - Dual Cylinder	HC6845	2	HA6804	1	H06820	1	25.0 - 26.5	635 - 673
					H06821		26.6 - 29.3	676 - 744
					H06822		29.4 - 34.2	747 - 869
					H06823		34.3 - 43.0	871 - 1092

RECOMMENDED STEERING KITS

STEERING SYSTEMS

Joystick

Order taking, delivery, technical support and warranty for these products are handled by SeaStar Solutions. Please consult your local SeaStar Solutions distributor or dealer if you need more detailed product information, price, availability and all business terms.

RECOMMENDED STEERING SYSTEM SUPPLIED BY



A higher level of engineering sophistication

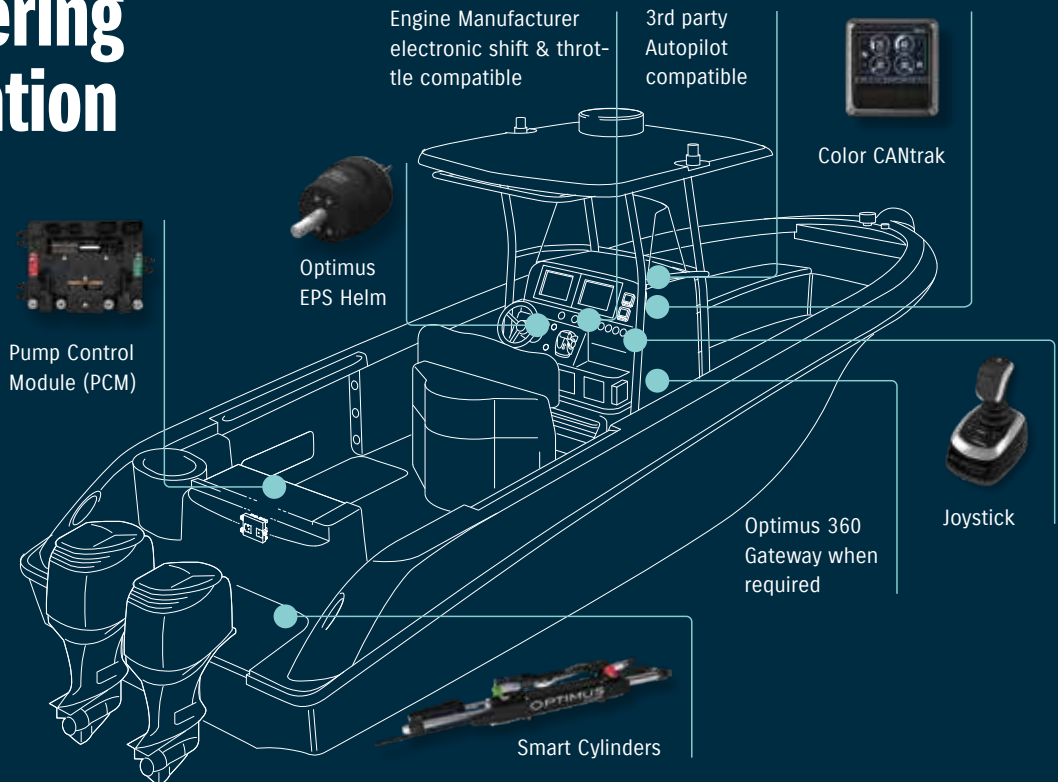

OPTIMUS EPS + JOYSTICK = OPTIMUS 360 JOYSTICK CONTROL



OPTIMUS EPS

The Optimus EPS system replaces the traditional hydraulic steering system. For single, twin, triple and quad engine applications.

Advantages of Optimus EPS:

- No oil at helm
- Boat that steers like a sports car
- Plug and play autopilot compatibility
- Auto adjusting speed sensitive wheel effort
- Auto adjusting speed sensitive turns lock to lock
- Can be retrofitted to existing mechanical and electronic controlled engines. You do not have to buy new engines
- No tie-bars (twin configuration)
- No liquid tie-bar (CAT)
- On demand pumps which extend battery life
- Components based on existing SeaStar reliability and quality
- NMEA 2000 Certified

OPTIMUS 360

The patented Optimus 360 system builds on the Optimus EPS. Optimus 360 steering is engineered for powerboats with electronic shift and throttle engines, allowing you to use the existing electronic controls. Optimus 360 connects to the existing control head with closed loop processing, providing a very seamless integration.

Advantages of Optimus 360:

- Intuitive high precision joystick allows docking with confidence
- Seamless integration with electronic controlled engines
- Autopilot ready - just a simple connection
- Dual station compatible
- Tiebar engines (triple) – less components, simple installation, less cost
- Available as a retrofit or for new engine installation
- All the benefits of Optimus EPS, including auto adjusting steering effort and steering turns lock to lock
- Supports Twin, Triple and Quadruple Suzuki Precision Control Engines
- Available with SeaStation (GPS anchor) and SeaWays

6

APPLICATION CHART

TRUSTED. EFFICIENT. SOPHISTICATED.





APPLICATION CHART

ITEM	DF350A		DF325A		DF300AP		DF250AP		DF200AP		DF175AP		DF150AP		DF150		DF140A	
	DF250ST	DF250T	DF250Z	DF225T	DF225Z	DF200T	DF200Z	DF200AT	DF200AZ	DF175AT	DF175AZ	DF150AST	DF150AT	DF150AZ	DF140AT	DF140AZ		
	DF350A	DF325A	DF300AP	DF250AP	DF200AP	DF175AP	DF150AP	DF150	DF140A									
SUZUKI MULTI-FUNCTION GAUGE	●	●	●	●	●	●	●	●	●	●	●	●	●	●	●	●	●	●
SUZUKI KEYLESS START SYSTEM	●	●	●	●	●	●	●	●	●	●	●	●	●	●	●	●	●	●
ANALOGUE INSTRUMENT							●	●	●	●	●	●	●	●	●	●	●	●
ELECTRONIC THROTTLE AND SHIFT SYSTEM																		
ELECTRONIC REMOTE CONTROL KIT	●	●	●	●	●	●	●											
ELECTRONIC REMOTE CONTROL BOX	●	●	●	●	●	●	●											
BATTERY LEAD	●	●	●	●	●	●	●											
MECHANICAL REMOTE CONTROL SYSTEM																		
MECHANICAL REMOTE CONTROL KIT							●	●	●	●	●	●	●	●	●	●	●	●
MECHANICAL REMOTE CONTROL BOX							●	●	●	●	●	●	●	●	●	●	●	●
BATTERY LEAD							●	●	●	●	●	●	●	●	●	●	●	●
REMOTE-CONTROL CABLE							●	●	●	●	●	●	●	●	●	●	●	●
REMOTE-CONTROL ATTACHING KIT																		
STEERING																		
TILLER HANDLE KIT																		
DUAL-ENGINE TIE-BAR					●	●	●	●	●	●	●	●	●	●	●	●	●	●
STEERING EXTENSION KIT					●	●	●	●	●	●	●	●	●	●	●	●	●	●
STEERING-BRACKET ATTACHMENT																		
DRAG-LINK KIT					●	●	●	●	●	●	●	●	●	●	●	●	●	●
ELECTRICAL PARTS																		
COUNTER SELECT CONNECTOR			●	●	●	●	●											
BATTERY ISOLATOR LEAD SET	●	●	●	●	●	●	●			●	●	●	●					
ELECTRIC STARTER KIT (ONLY FOR MZ type)																		
BATTERY CHARGING KIT (ONLY FOR MZ type)																		
RECTIFIER SET (ONLY FOR MZ type)																		
RECEPTACLE KIT (ONLY FOR MZ type)																		
ANODE	●	●	●	●	●	●	●	●	●	●	●	●	●	●	●	●	●	●
FUEL SYSTEM	●	●	●	●	●	●	●	●	●	●	●	●	●	●	●	●	●	●

ITEM	DF90A	DF70A	DF60A		DF50A		DF40A	DF30A			DF25A			DF20A	DF15A		DF9.9B							
	DF90ATH	DF70ATH	DF60ATH	DF60AQH	DF60AVTH	DF50ATH	DF50AQH	DF50AVTH	DF40ATH	DF40AQH	DF30A	DF30ATH	DF30AQH	DF25A	DF25ATH	DF25AQH	DF20A	DF20ATH	DF15A	DF15ATH	DF9.9B	DF9.9BTH	DF9.9A	
SUZUKI MULTI-FUNCTION GAUGE																								
SUZUKI KEYLESS START SYSTEM																								
ANALOGUE INSTRUMENT																								
ELECTRONIC THROTTLE AND SHIFT SYSTEM																								
ELECTRONIC REMOTE CONTROL KIT																								
ELECTRONIC REMOTE CONTROL BOX																								
BATTERY LEAD																								
MECHANICAL REMOTE CONTROL SYSTEM																								
MECHANICAL REMOTE CONTROL KIT																								
MECHANICAL REMOTE CONTROL BOX																								
BATTERY LEAD	●	●																						
REMOTE-CONTROL CABLE																								
REMOTE-CONTROL ATTACHING KIT										●	●	●	●	●	●	●	●	●	●	●	●	●	●	●
STEERING																								
TILLER HANDLE KIT																								
DUAL-ENGINE TIE-BAR																								
STEERING EXTENSION KIT																								
STEERING-BRACKET ATTACHMENT	●	●	●	●	●	●	●	●	●	●	●	●	●	●	●	●	●	●	●	●	●	●	●	●
DRAG-LINK KIT																								
ELECTRICAL PARTS																								
COUNTER SELECT CONNECTOR																								
BATTERY ISOLATOR LEAD SET																								
ELECTRIC STARTER KIT (ONLY FOR MZ type)										●		●	●		●	●		●		●		●	●	●
BATTERY CHARGING KIT (ONLY FOR MZ type)										●		●	●		●	●		●		●		●	●	●
RECTIFIER SET (ONLY FOR MZ type)										●		●	●		●	●		●		●		●	●	●
RECEPTACLE KIT (ONLY FOR MZ type)										●		●	●		●	●		●		●		●	●	●
ANODE	●	●	●	●	●	●	●	●	●	●	●	●	●	●	●	●	●	●	●	●	●	●	●	●
FUEL SYSTEM	●	●	●	●	●	●	●	●	●	●	●	●	●	●	●	●	●	●	●	●	●	●	●	●

DF115A			DF100A	DF100B	DF90A	DF80A	DF70A	DF60A				DF50A			DF40A	DF40AS	DF30A		DF25A		DF20A		DF15A	DF9.9B		DF9.9A	DF8A	DT40	DT30
DF115AST	DF115AT	DF115AZ	DF100AT	DF100BT	DF90AT	DF80AT	DF80AT	DF60AT	DF60AV	DF50AT	DF50AV	DF40AT	DF40AST	DF30AR	DF30AT	DF25AR	DF25AT	DF20AR	DF20AT	DF15AR	DF9.9BR	DF9.9BT	DF9.9AR	DF8AR	DT40WR	DT30R			
●	●	●	●	●	●	●	●	●	●	●	●	●	●	●	●	●	●	●	●	●	●	●	●	●	●	●	●	●	●
●	●	●	●	●	●	●	●	●	●	●	●	●	●	●	●	●	●	●	●	●	●	●	●	●	●	●	●	●	●
●	●	●	●	●	●	●	●	●	●	●	●	●	●	●	●	●	●	●	●	●	●	●	●	●	●	●	●	●	●
●	●	●	●	●	●	●	●	●	●	●	●	●	●	●	●	●	●	●	●	●	●	●	●	●	●	●	●	●	●
●	●	●	●	●	●	●	●	●	●	●	●	●	●	●	●	●	●	●	●	●	●	●	●	●	●	●	●	●	●
●	●	●	●	●	●	●	●	●	●	●	●	●	●	●	●	●	●	●	●	●	●	●	●	●	●	●	●	●	●
●	●	●	●	●	●	●	●	●	●	●	●	●	●	●	●	●	●	●	●	●	●	●	●	●	●	●	●	●	●
●	●	●	●	●	●	●	●	●	●	●	●	●	●	●	●	●	●	●	●	●	●	●	●	●	●	●	●	●	●
●	●	●	●	●	●	●	●	●	●	●	●	●	●	●	●	●	●	●	●	●	●	●	●	●	●	●	●	●	●
●	●	●	●	●	●	●	●	●	●	●	●	●	●	●	●	●	●	●	●	●	●	●	●	●	●	●	●	●	●

DF8A	DF6A	DF5A	DF4A	DF2.5	DT40		DT30	DT25	DT15A		DT9.9A	
DF8A	DF6A	DF5A	DF4A	DF2.5	DT40W	DT40WK	DT30	DT25K	DT15A	DT15AK	DT9.9A	DT9.9AK
●												
●	●	●	●		●		●					
●	●	●	●		●		●					
●	●	●	●		●		●					
●	●	●	●		●		●					
●	●	●	●	●	●		●					
●	●	●	●	●	●		●					
●	●	●	●	●	●		●					



7 MERCHANDISE

STYLISH. FUNCTIONAL. AUTHENTIC.



MERCHANDISE



MARINE POLO SHIRT LADIES

Lake Hamana white polo shirt with dark blue collar.

95 % cotton, 5 % elastane.

XS/S/M/L/XL



MARINE POLO SHIRT MEN

Lake Hamana white polo shirt with dark blue collar.

100 % cotton.

S/M/L/XL/XXL



MARINE CAP

Lake Hamana dark blue/white cap. 100 % cotton.

One size fits all.



MARINE T-SHIRT

Lake Hamana dark blue T-Shirt with white print. 100% cotton. S/M/L/XL/XXL



MARINE HOODIE

Lake Hamana dark blue full-zip hoodie jacket with embroidered logos and Suzuki Marine rubber badge. 100% polyester. S/M/L/XL/XXL



BERMUDA SHORTS MEN

Blue men Bermuda shorts with 6 pockets. 65% modal, 32% polyester, 3% elastane. Including textile belt. 80% polyester, 20% polyamide. S/M/L/XL/XXL

MERCHANDISE



WATCH MEN

Black stainless steel case. Date and time function, silicone strap, clock-face with carbon insets, mineral crystal watch glass, diameter 44 mm, 5 ATM water resistant. Comes with black gift box.

WATCH LADIES

Black stainless steel case. Date and time function, silicone strap, clock-face with carbon insets, mineral crystal watch glass, diameter 32 mm, 5 ATM water resistant. Comes with black gift box.



MARINE TOWEL

Lake Hamana blue towel, 100% cotton. Dimensions 140 x 70 cm.



MARINE KEY RING

Signal yellow floatable key ring, neoprene outer material, useful for max. 3 standard keys (max. 40 gr. total).



SUNGLASSES

Stylish and lightweight, with 100% UVA and B protection, made from acrylic with embossed Suzuki logo. Comes with EVA case and microfiber pouch.



I LOVE SUZUKI TEDDY

Plush, soft teddy wearing "I LOVE SUZUKI" pullover. Sitting 19 cm high.

BACKPACK

Daypack, functional addition to touring luggage, multiple functional pockets, bottle holder, waist and chest belts, incl. rain cover, opening for a drinking tube (not included), 600D polyester. Size: (H) 44 cm, (W) 25 cm, (D) 16 cm, (C) 24 litres.



WATERPROOF BACKPACK

Light waterproof backpack with integrated padded laptop sleeve (up to 15.4" devices), additional outer pocket, PVC fabric. Size: (H) 45 cm, (W) 35 cm, (D) 17 cm, (C) 26 litres.



DRY BAG

Dry bag made of welded tarpaulin, reflective details, additional shoulder belt included. Size: (H) 30 cm, (W) 30 cm; (D) 55 cm, (C) 35 liters.

Suzuki's "Way of Life!" is the heart of our brand - every Suzuki vehicle, motorcycle and outboard motor is built to create excitement so customers can enjoy everyday life.



Please read your Owner's Manual carefully. Remember, boating and alcohol or other drugs don't mix. Always wear a personal flotation device when boating. Please operate your outboard safely and responsibly.

Suzuki encourages you to operate your boat safely and with respect for the marine environment.

Specifications, appearances, equipment, colors, materials and other items of "SUZUKI" products shown in this catalogue are subject to change by manufacturers at any time without notice and they may vary depending on local conditions or requirements. Some models are not available in some territories. Each model might be discontinued without notice. Please enquire at your local dealer for details of any such changes. Actual body color might differ from the colors in this brochure.



Suzuki Deutschland GmbH
Suzuki-Allee 7, 64625 Bensheim
Germany

2019 OBM RIGGING PART
CATALOGUE (RETAIL)

Your AUTHORIZED SUZUKI DEALER

THE
ULTIMATE™
4-STROKE OUTBOARD



Way of Life!